

The logo for SENSE is the word 'SENSE' in a red, serif font. The letters 'S', 'E', and 'E' have horizontal lines through them, and the 'N' is slightly taller than the other letters. The logo is positioned on a white rectangular background that is part of a larger grey geometric shape on the right side of the slide.

# Assuring integrity of CO<sub>2</sub> storage sites through ground surface monitoring (SENSE)

Bahman Bohloli & Joonsang Park  
Norwegian Geotechnical Institute

Presentation for NPD  
Jan 10, 2022  
Digital meeting

# Outline

- Introduction
- Objective of SENSE project
- Case studies and achievements
- Summary

# Introduction: monitoring methods

## SENSE focuses on

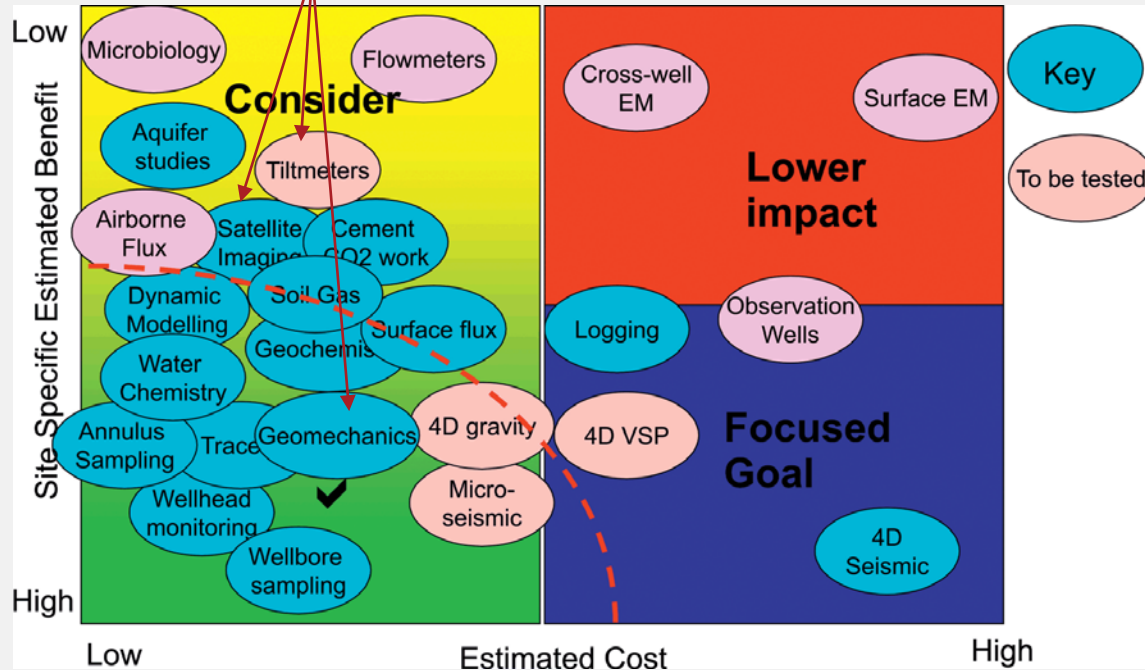

# Introduction: SENSE consortium



# SENSE project concept

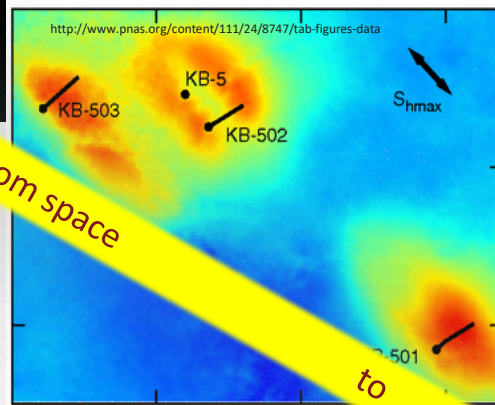
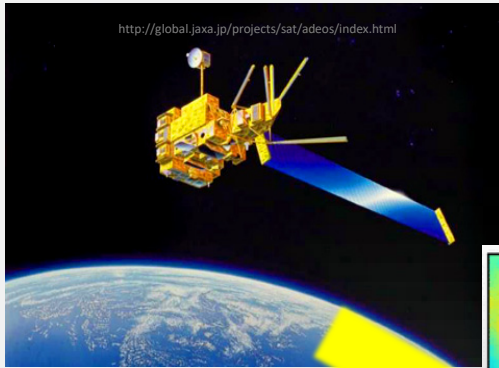

Demonstration of concept onshore



Demonstration offshore

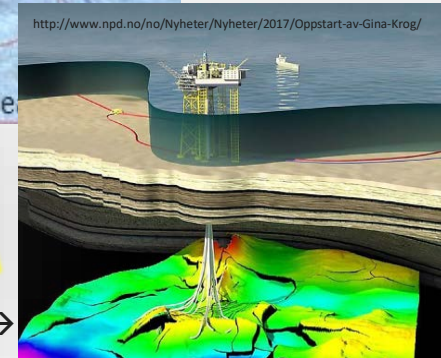

- Estimation of ground deformation (via modelling)

- Measure ground deformation (satellite for onshore-pressure sensors/fiber optics for offshore)

- Analyse measured vs estimated deformation:

- agreement with estimations → OK
- anomaly → **Alert** on performance/integrity issues

# SENSE objective

## ➤ Ground motion measurement for **continuous, cost efficient** CO<sub>2</sub> storage monitoring **over large areas**:

- Demonstrate tools & methods in field cases (onshore, offshore)
- Optimization of sampling configuration for monitoring ground surface/seafloor
- Models & inversion to provide information on pressure distribution and hydraulic behavior of subsurface
- Improvement of geomechanical constraints for storage performance and integrity



- Safe storage of CO<sub>2</sub> in long-term  
(Early warning in case of unexpected events)

# Project Structure

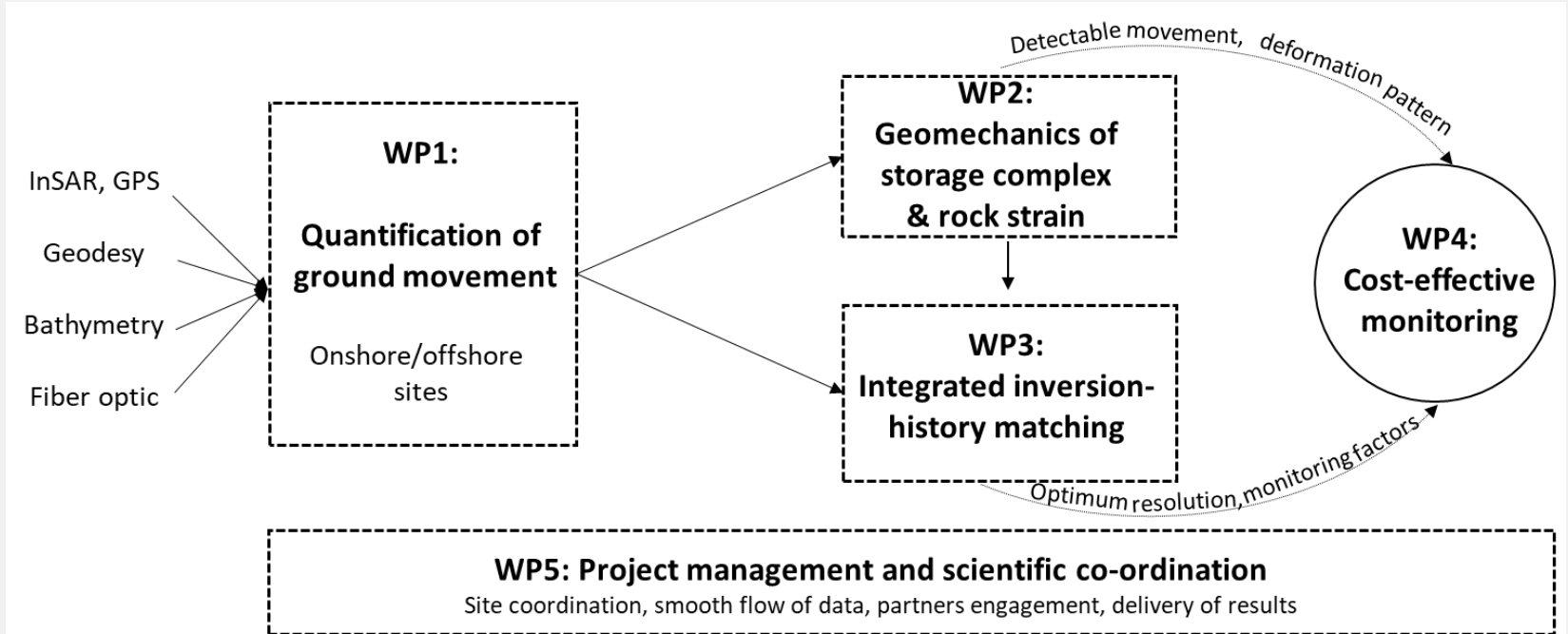



# WP1: Measurement of ground deformation- case studies

1. In Salah/Troll Subsidence data
2. Boknis Eck, Offshore Germany
3. Hatfield Moors, onshore US
4. Gulf of Mexico

3. Hatfield Moors, natural gas storage, sandstone, 450 m deep

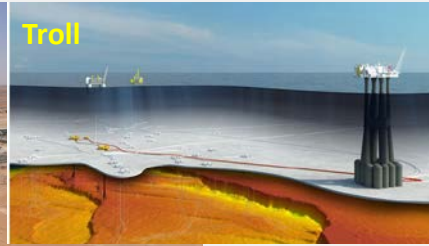





# InSalah: Injection vs. Post-Injection Phase

**Injection: 2004 – 2010 (ENVISAT)**

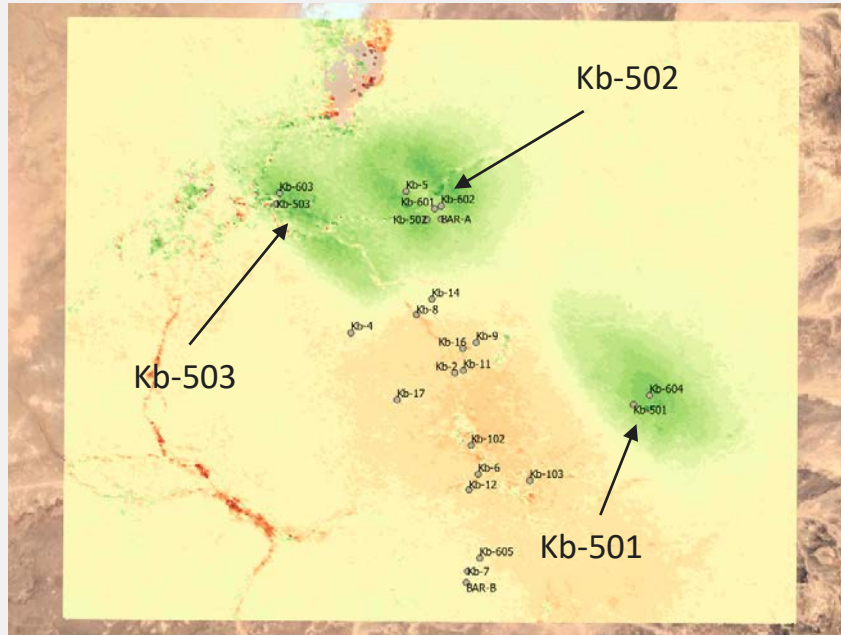

**Post-Injection: 2010 – 2016 (TerraSAR-X)**

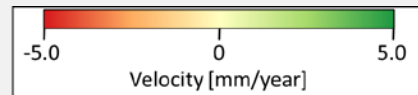
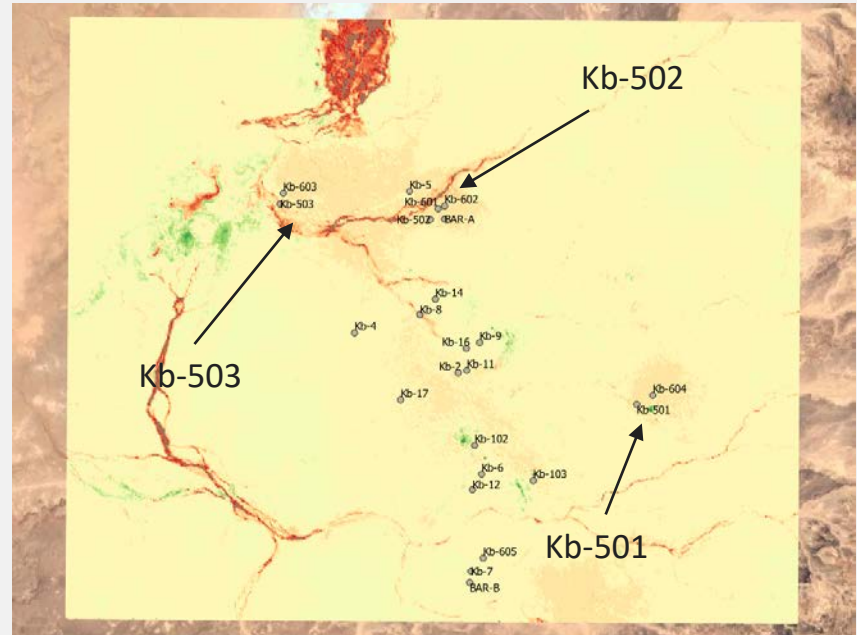

# CONCEPTUAL MODELING- IMPACT OF FAULT PERMEABILITY ON GROUND DEFORMATION

- Reservoir at a 1600 m depth, 50 m thick
- 2800 t/d injection, 160 bar/40°C conditions, injection controlled by a 50 bar overpressure
- Injection well: 6 km from anticline summit
- Injection constrained by a max. overpressure [50 bar], max. inj. rate of **2800 t/d** (surface)
- Depth, thickness of storage formation and overburden are scenario-dependent.

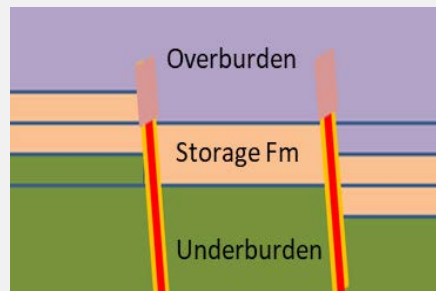

Faults (core and damage zones ) with throw

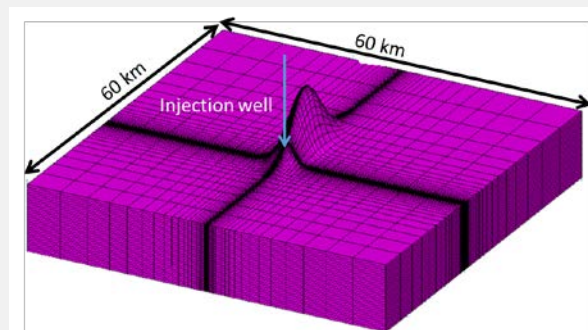
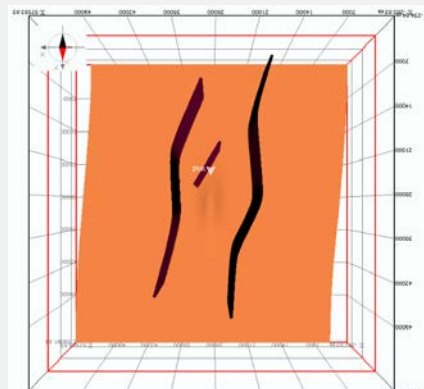

Anticline trap

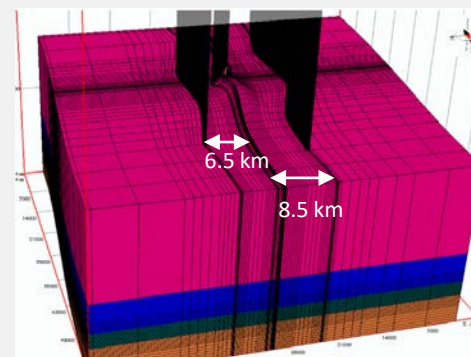

Anticline trap with sealing or draining faults

# Impact of fault permeability of ground uplift

## *Anticline trap with sealing or draining faults*

### Draining fault

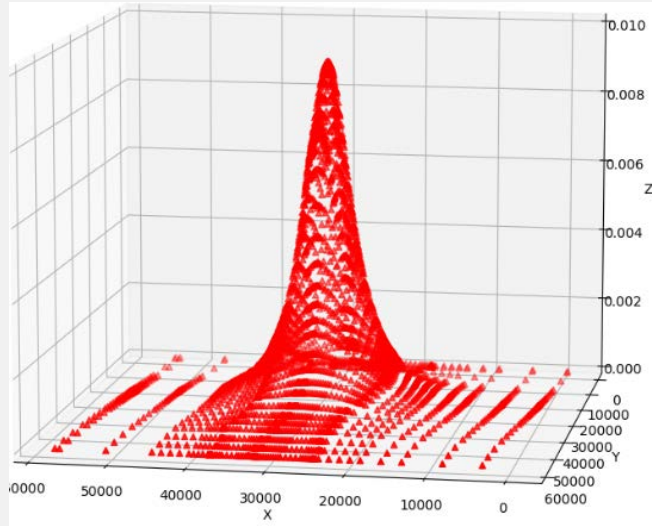

Pressure difference  
Sealing – Draining Faults scenarii [bar]

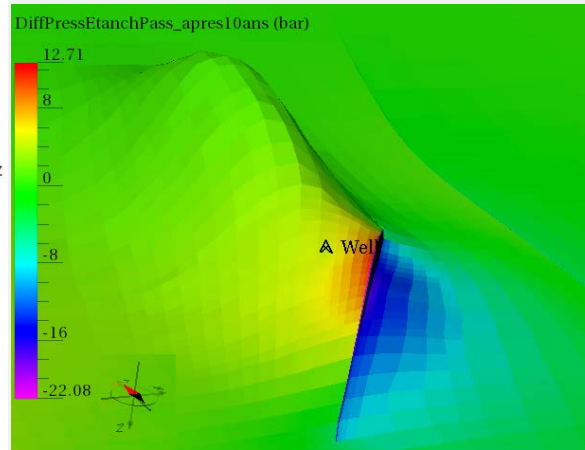

### Sealing fault

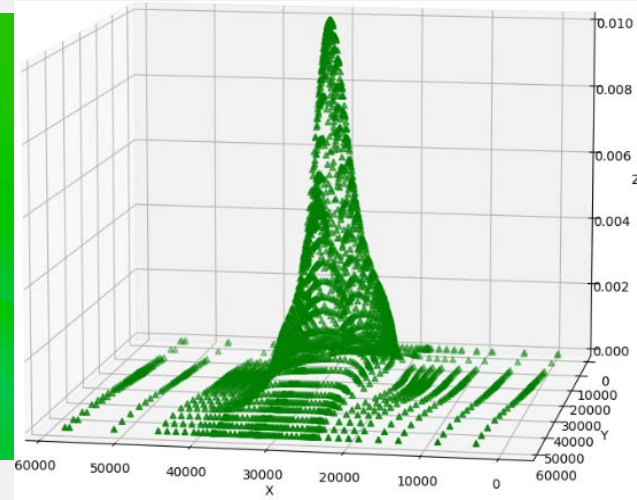

# Can we measure mm-scale ground deformation?

## Fiber optics (Distributed Strain Sensing-DSS)

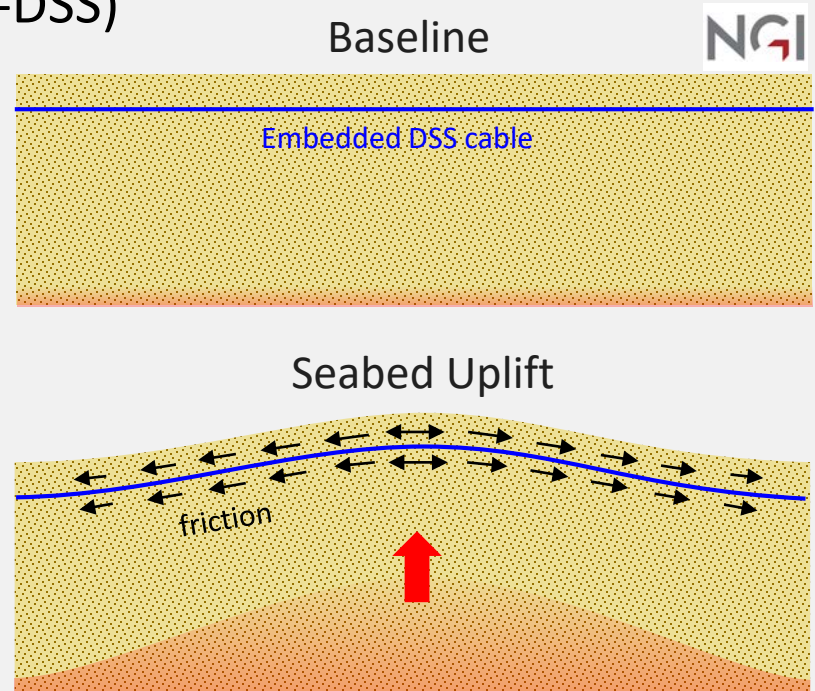
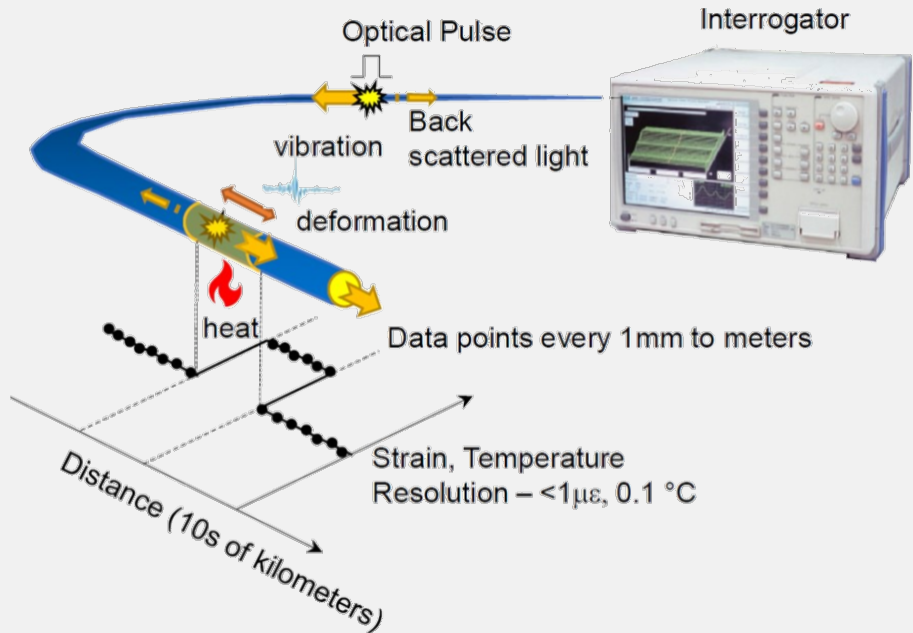

The magnitude of tension (axial strain) along the DSS cable depends on the radial deformation, slope gradient and soil-cable friction

# Controlled tests in a sandbox

- Investigate the DSS cable sensitivity to heave deformations
- Investigate the effect of soil-cable interaction (friction) and pre-tensioning
  - Investigate the effect of micro anchors
  - Investigate the effect of overburden
- How to convert and quantify the measured axial strain to radial (vertical) deformations?

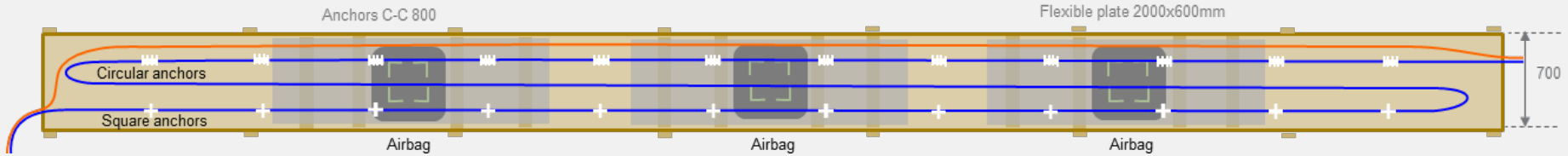

Plane view of 10.5m long sandbox with embedded DSS cable and 3 lifting points

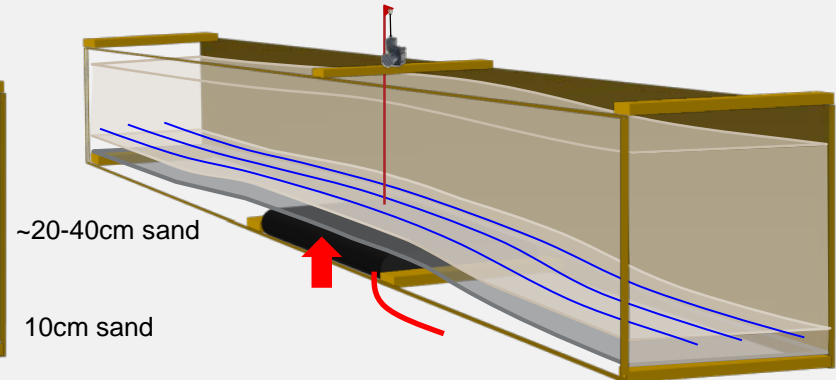
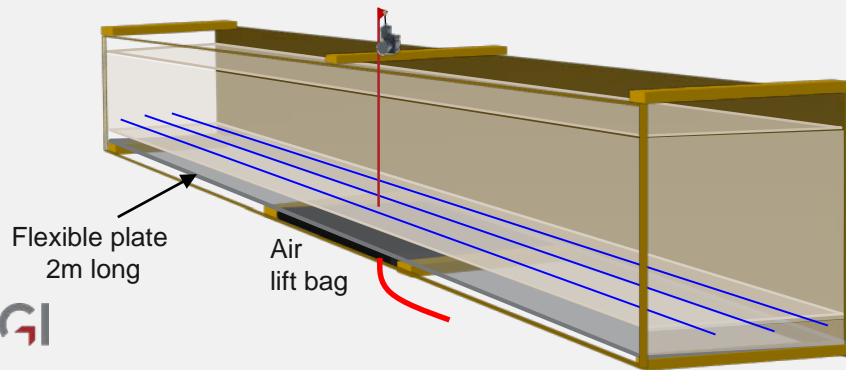



# Controlled tests in sandbox - NGI

## Test arrangement

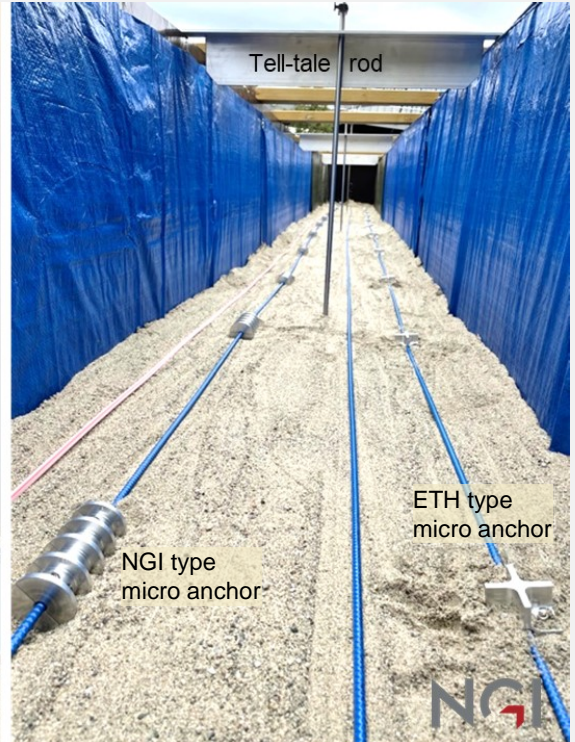
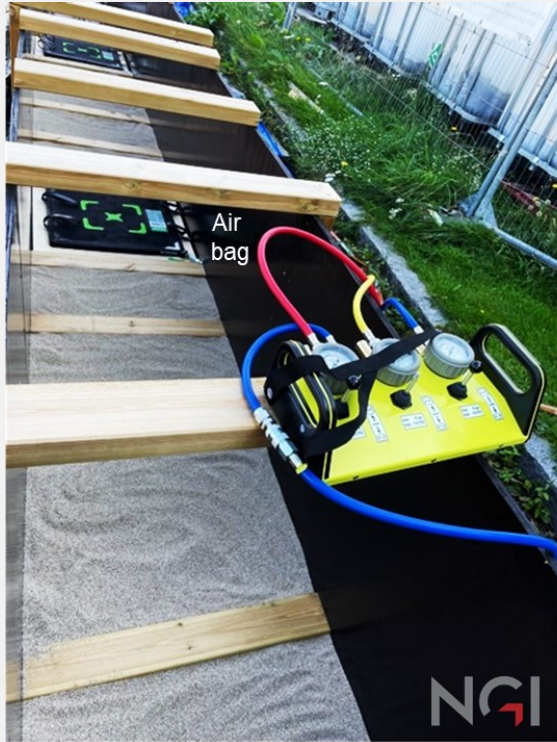

# Controlled tests in sandbox

Example of results – small deformations - without micro anchors

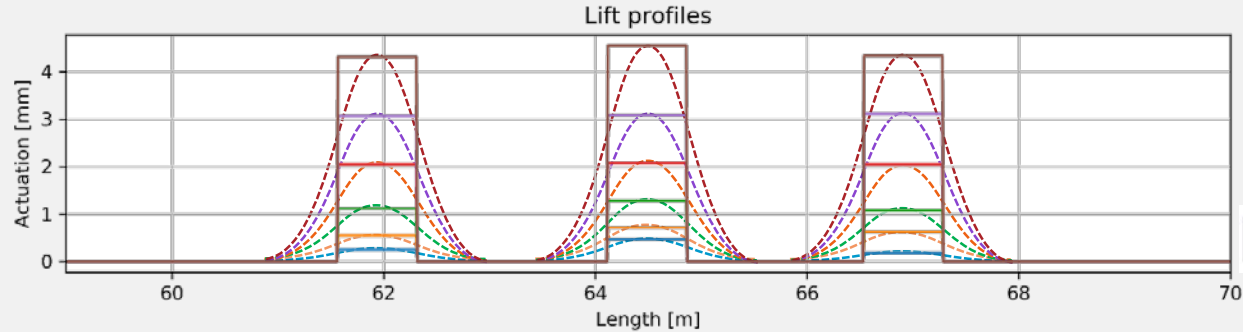
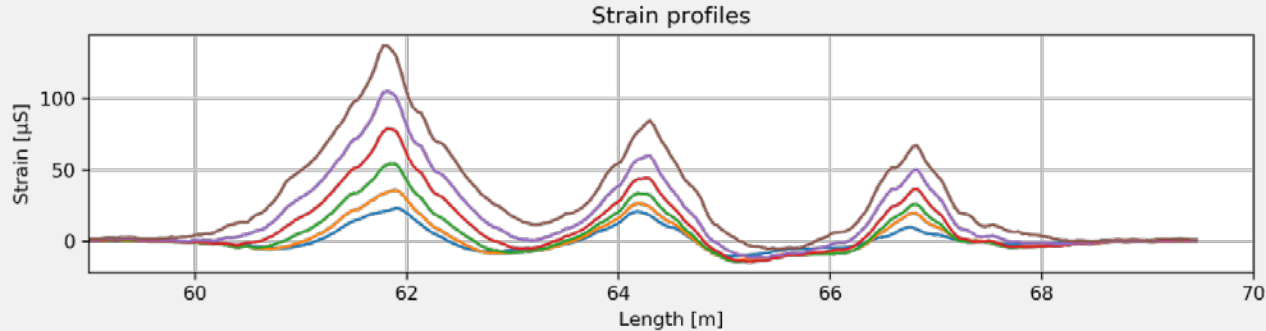



# DSS Cable test at Boknis Eck



# DSS Cable test at Boknis Eck

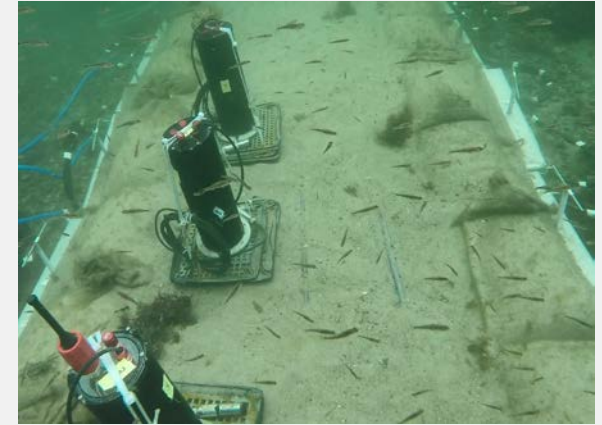
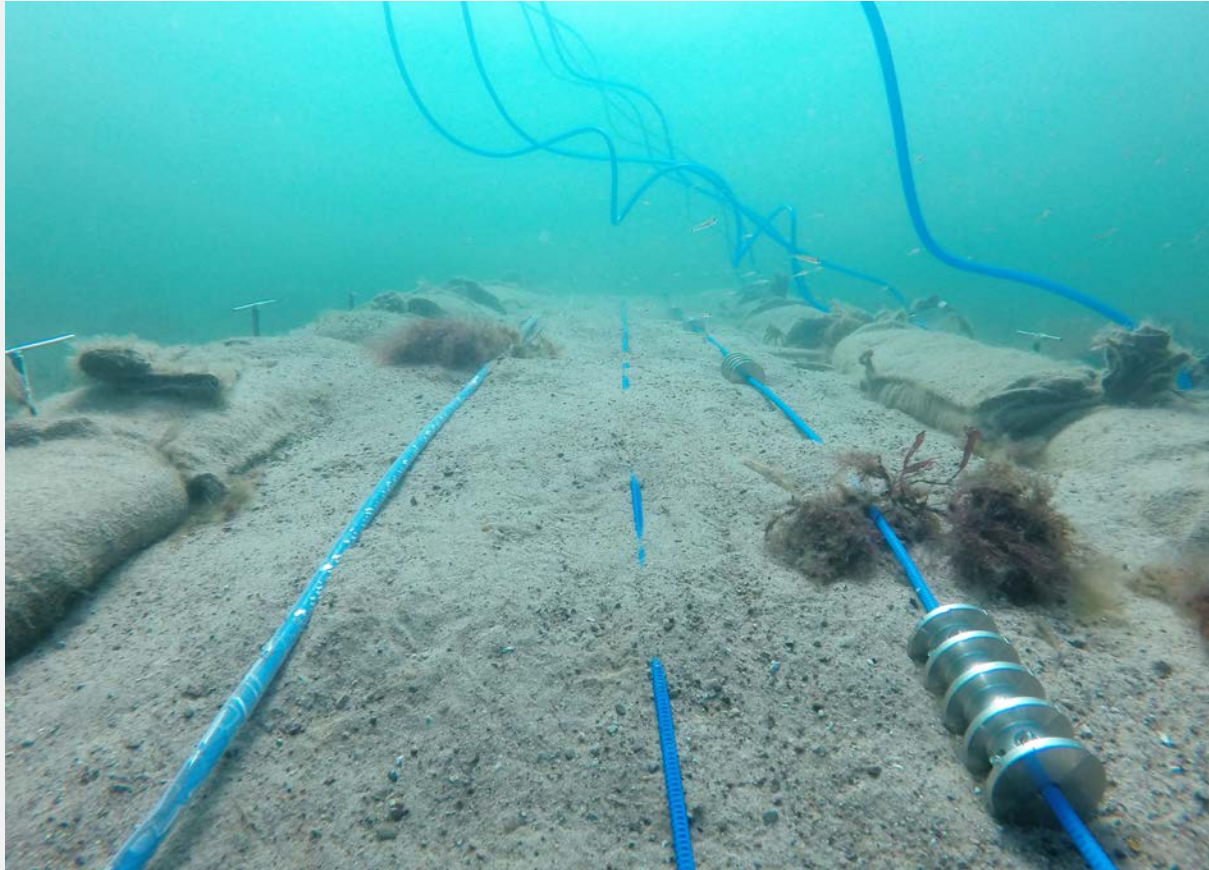

The nearshore tests were less controlled, similar ground deformation sensitivity as in NGI's sandbox was demonstrated



# Troll Field

## Subsidence 2017-2012

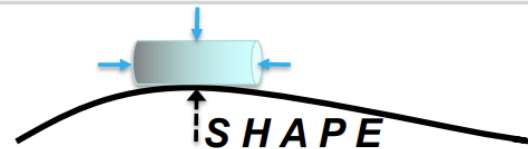

observed subsidence 2017-2012

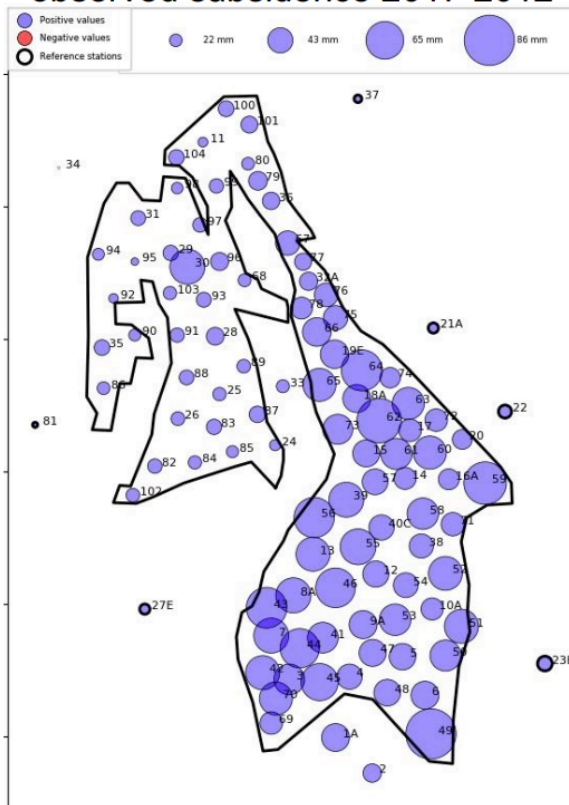

Reservoir thickness

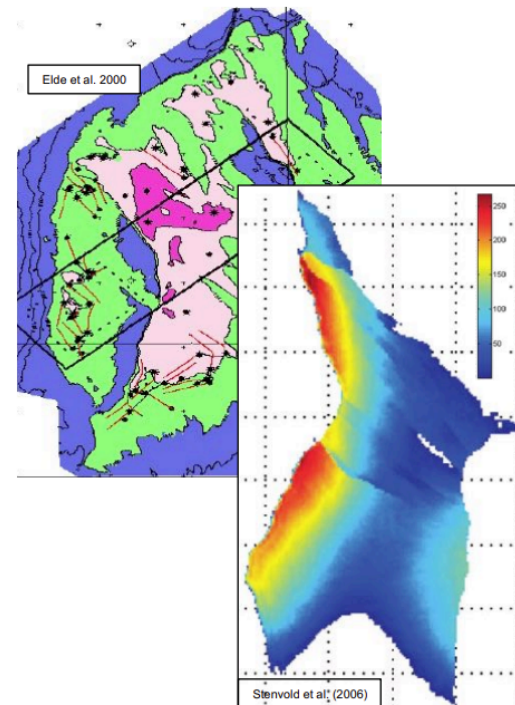

# Case Study: Gulf of Mexico-Lawrence Livermore National Lab

Storage Capacity  
Estimates, Texas Gulf  
Coast [Gulf-Coast Carbon  
Atlas]

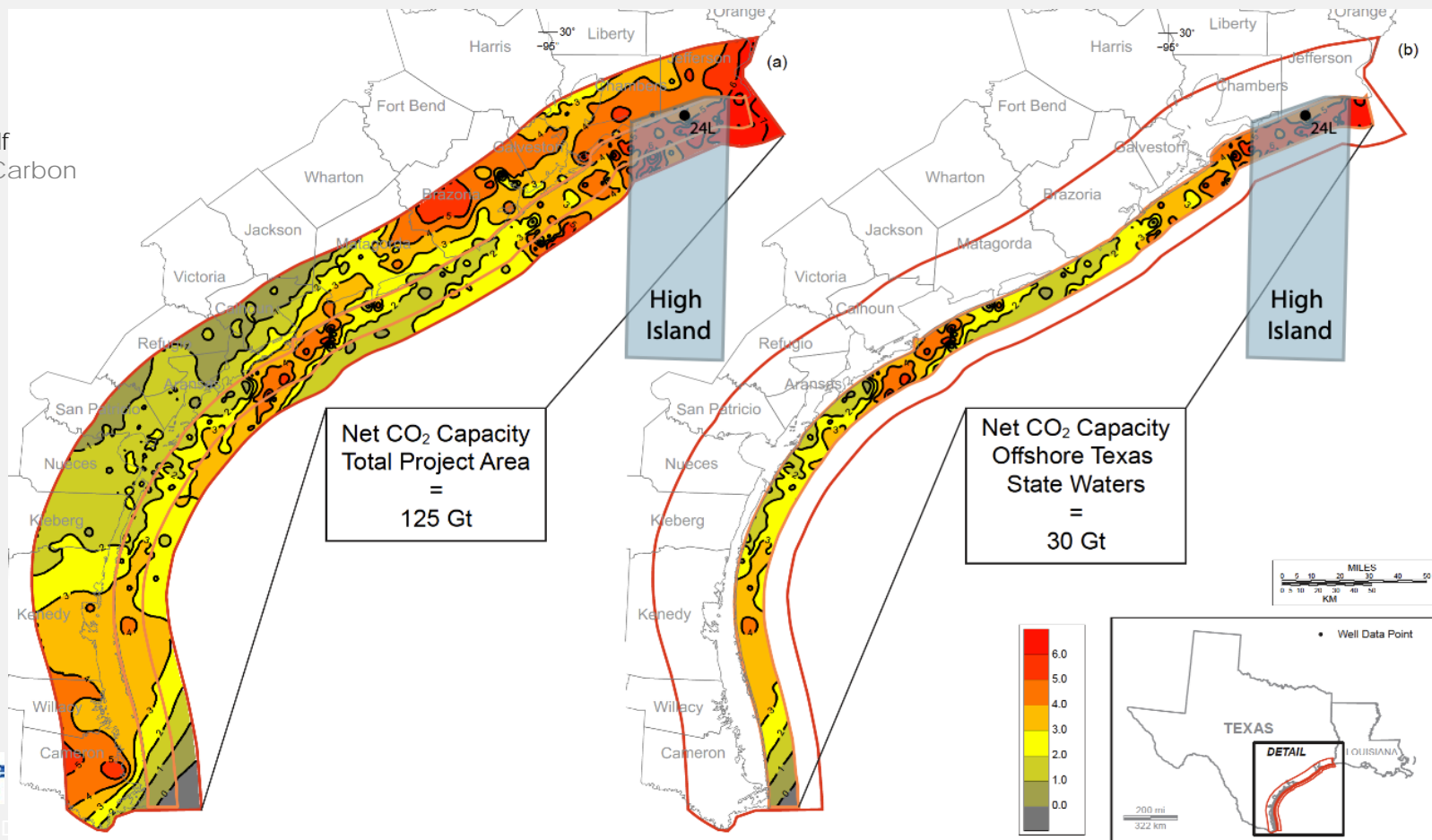

# GoM model

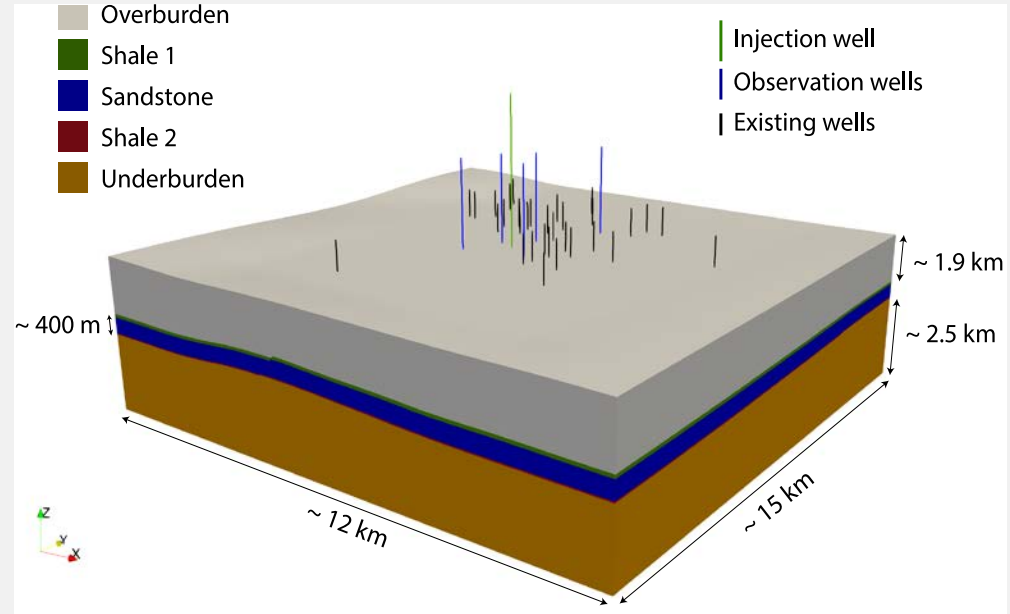
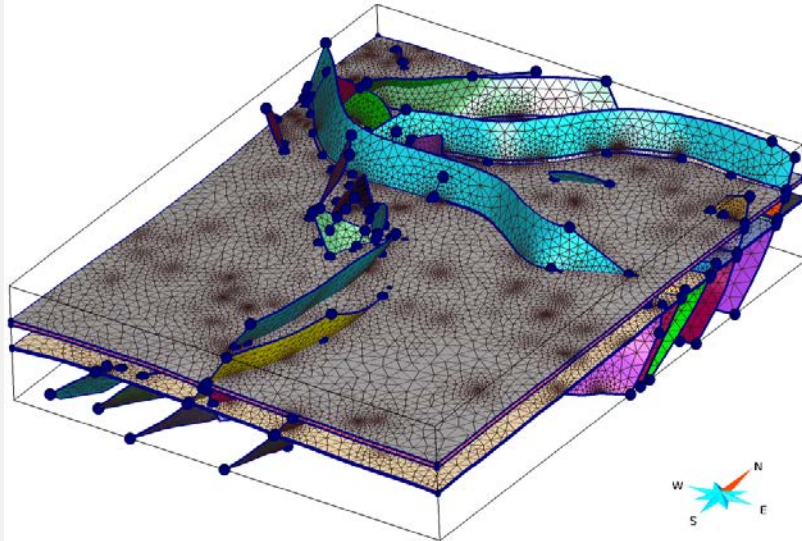
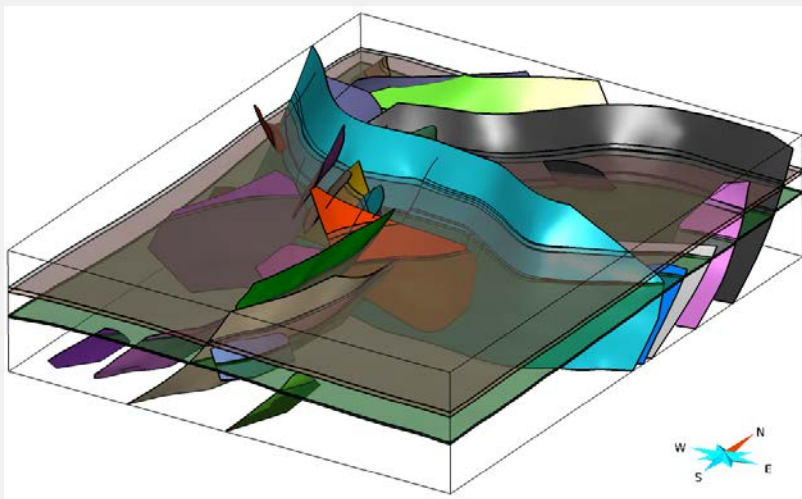

# Seabed uplift

Reservoir excess pressure

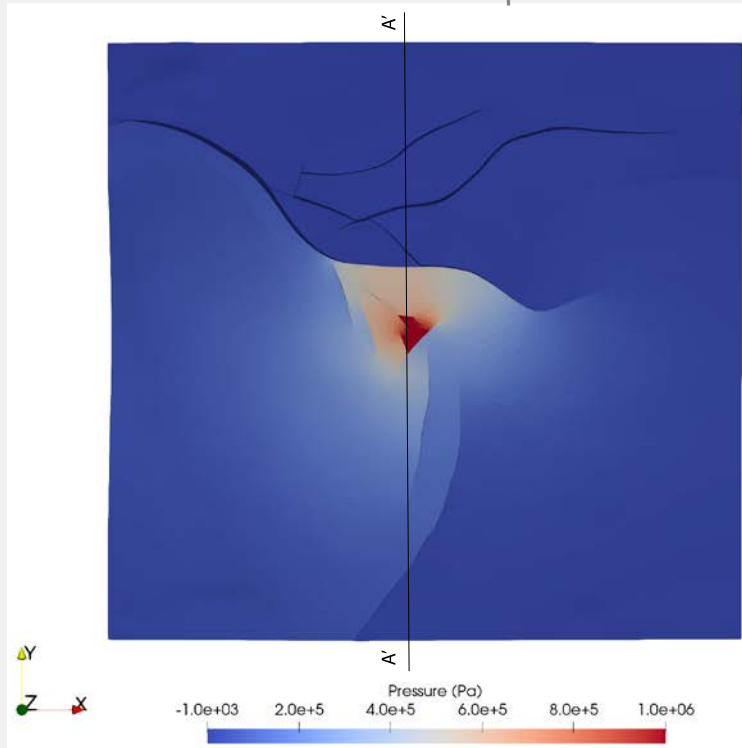

seabed displacement

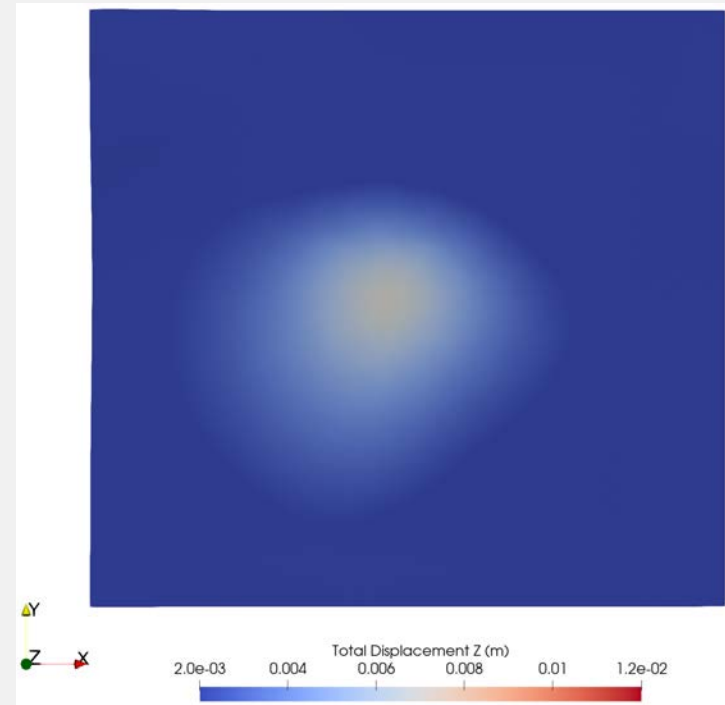

# Predict monitoring observations

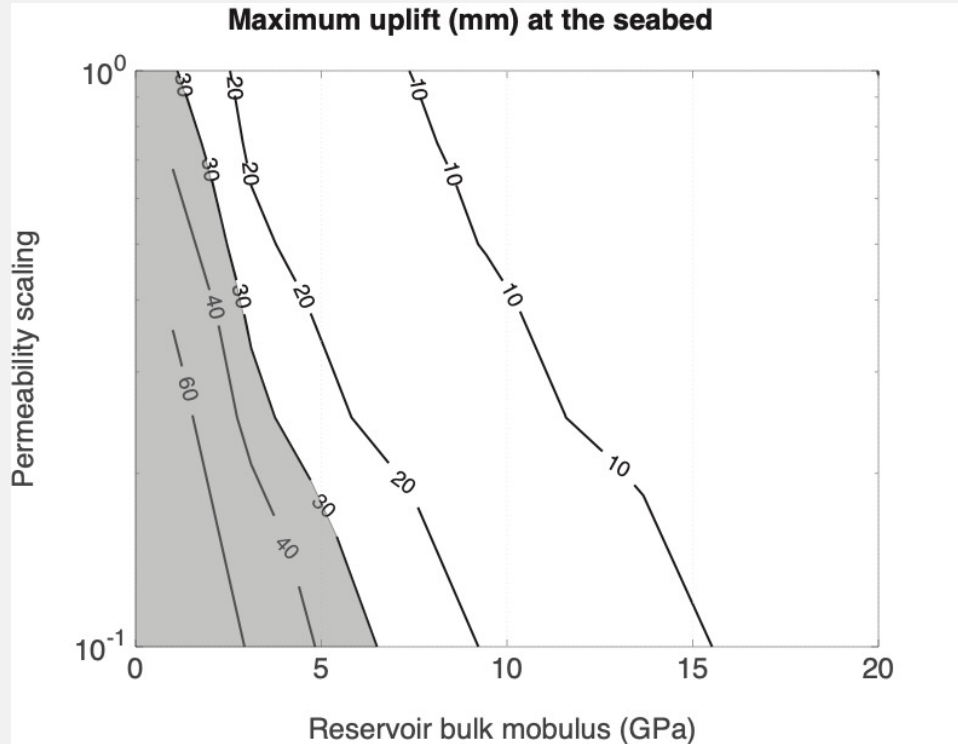

## Conclusion:

Both fiber optic and ocean-bottom-pressure sensors could likely provide useful monitoring of GoM storage sites.

Figure: Sensitivity to property uncertainty



# History matching and inversion

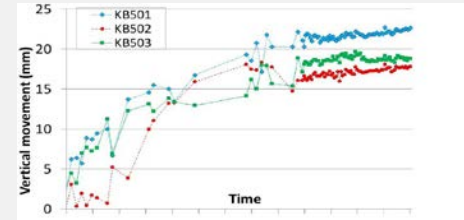
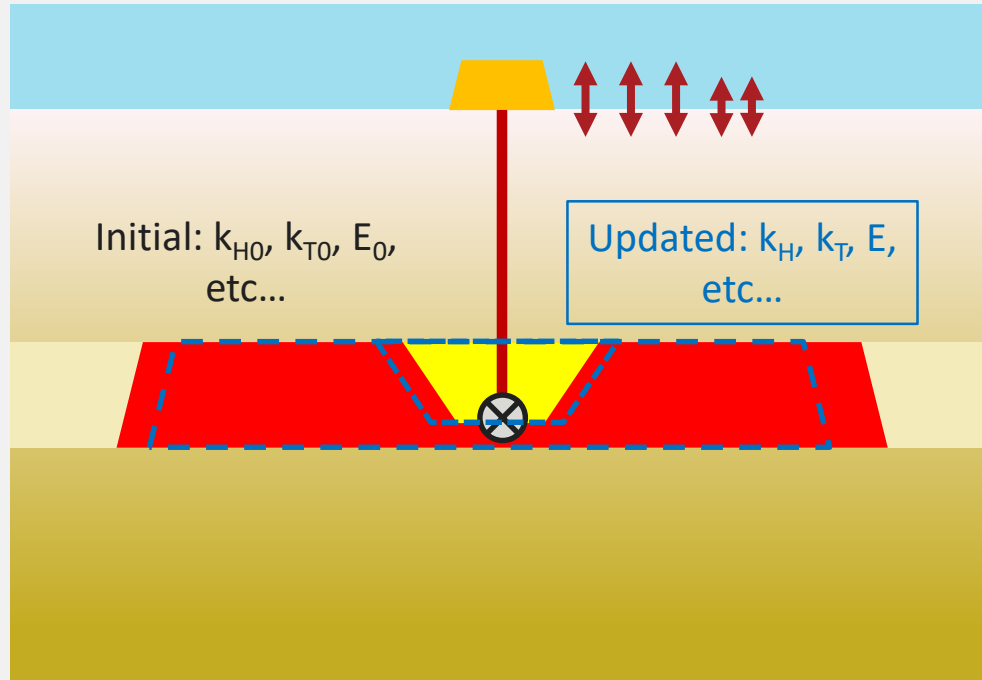

“with survey cost issue”

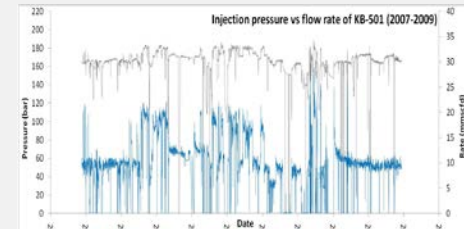

# Background and Motivation (In Salah experience)

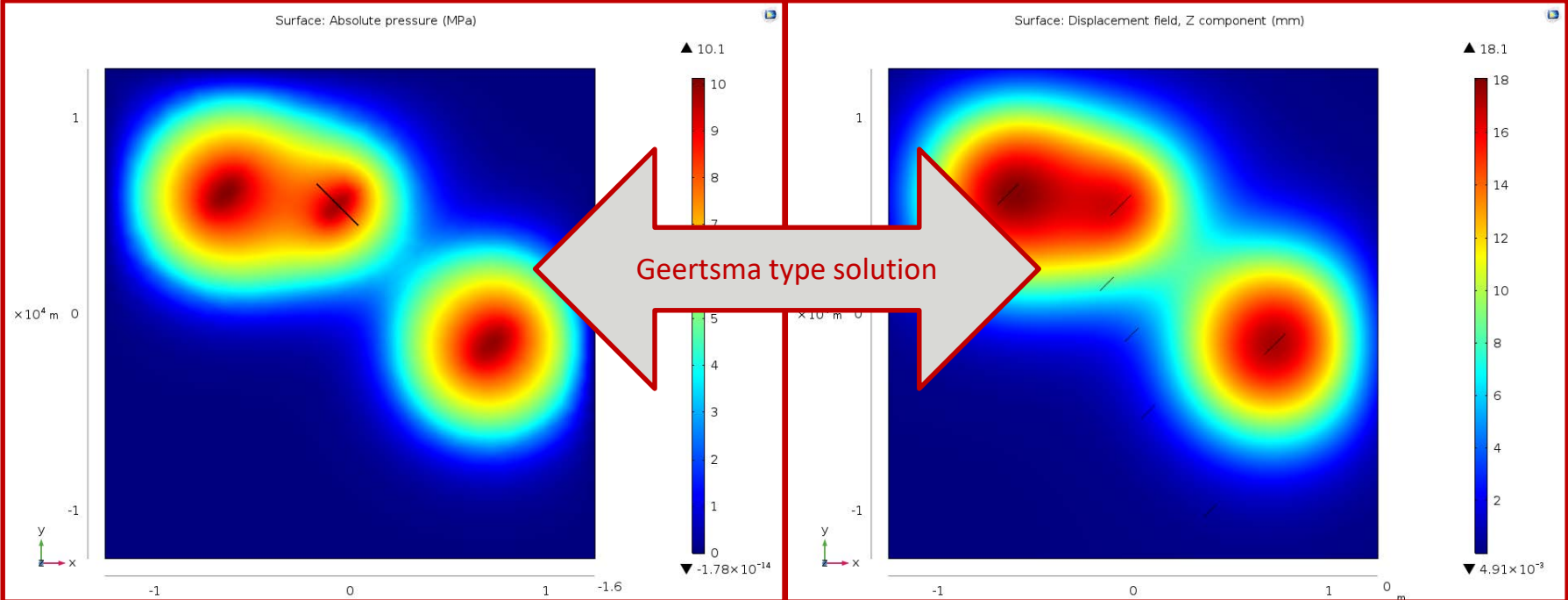

reservoir pressure change

surface heave

# Generalized Geertsma solution from SENSE

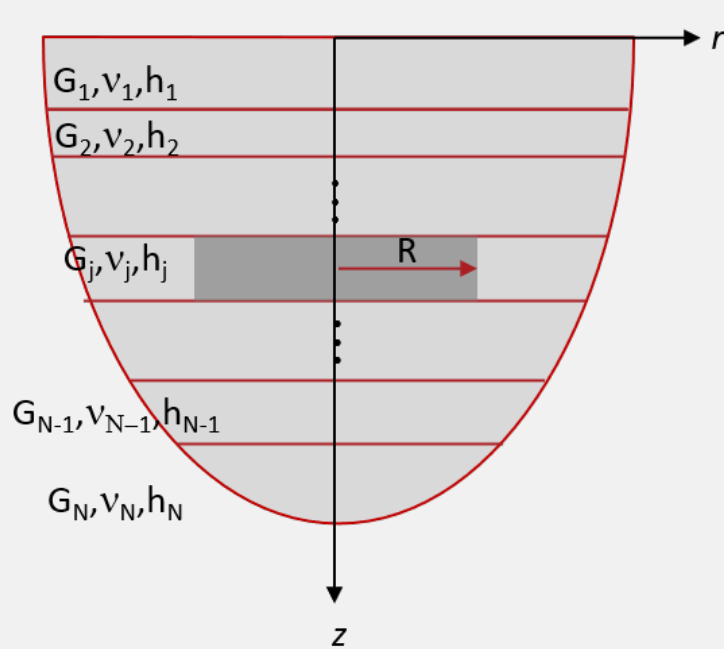

- Any number and thickness of layers can be simulated.
- We can calculate deformation and stress at any layer for «static» pressure or temperature distribution applied at any layer.
- Any boundary condition is available e.g. rigid basement (e.g. Tempone et al., 2010).
- Matlab and Python scripts are implemented.
- Anisotropy medium model can also be considered i.e.  $G_h/G_v \neq 1$ . (Park et al. 2021)

# For realistic pressure distribution

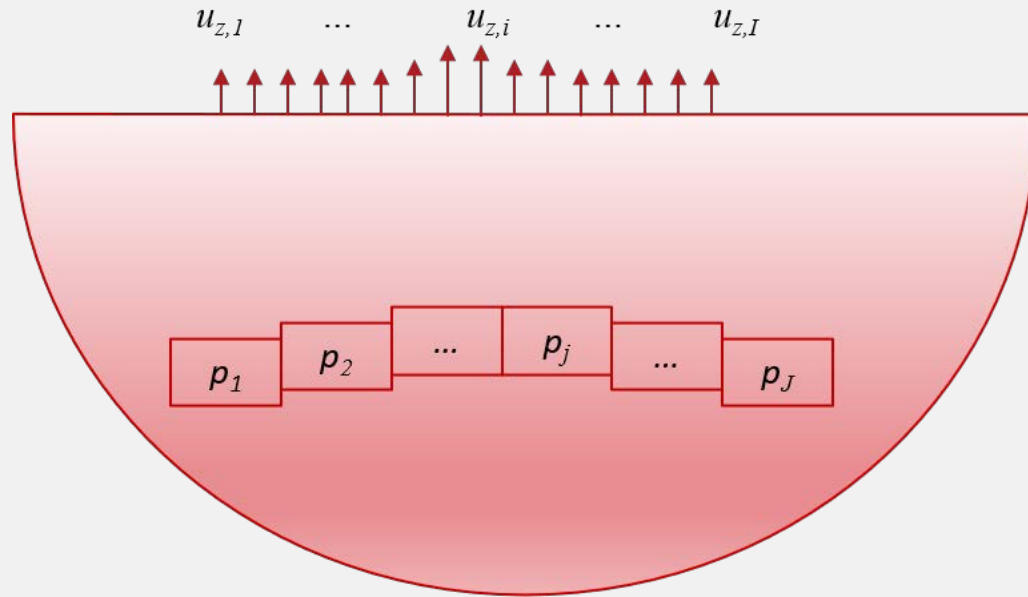

$$\curvearrowright u_{z,i} = \sum_{j=1}^J g_{z,ij} p_j$$

$$\curvearrowright \mathbf{U}_z = \mathbf{G}_z \mathbf{P}$$

$$- \mathbf{U}_z = [u_{z,1}, u_{z,2}, \dots, u_{z,i}, \dots, u_{z,I}]^T,$$

$$- \mathbf{P} = [p_1, p_2, \dots, p_j, \dots, p_J]^T,$$

$$- \mathbf{G}_z = \begin{bmatrix} g_{z,11} & \cdots & g_{z,1J} \\ \vdots & \ddots & \vdots \\ g_{z,I1} & \cdots & g_{z,IJ} \end{bmatrix}$$

$$\curvearrowright \mathbf{P} = \mathbf{G}_z^{-1} \mathbf{U}_z$$

# Effects of heave data noise via synthetic data

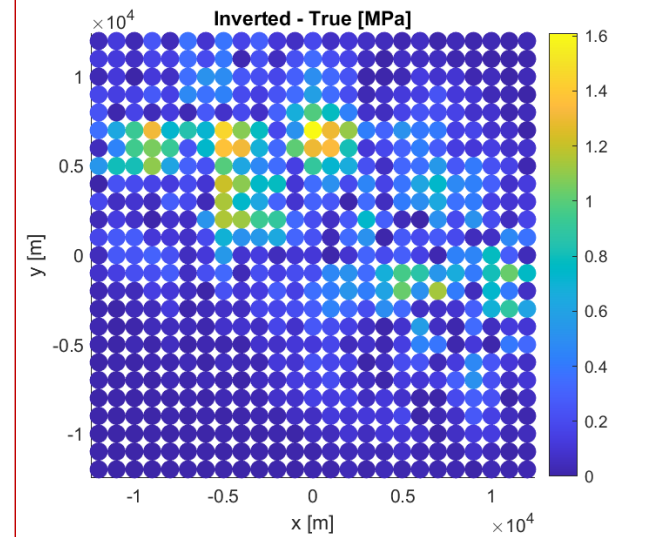
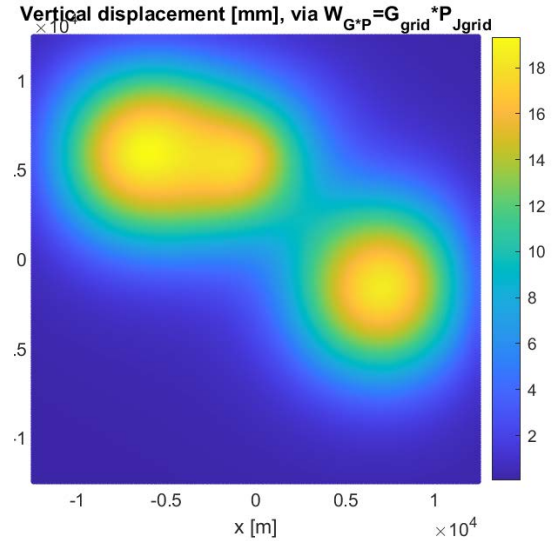
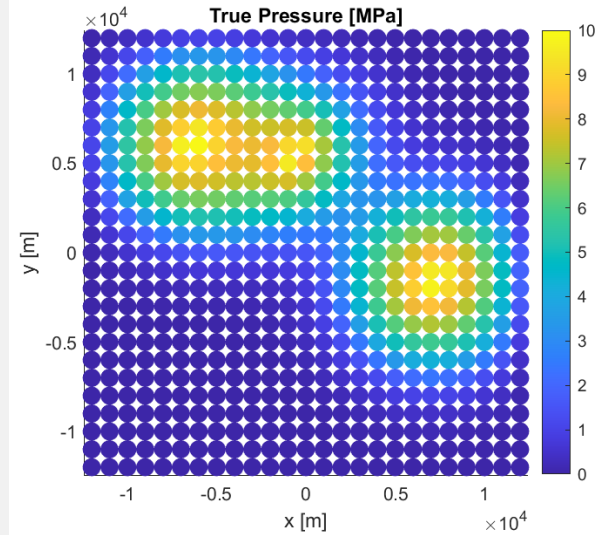

$$G_z P = U_z$$

$$G_z^{-1} U_{z,3\%} = P$$

## Highlight: ML-based inversion (pressure-deformation pattern training)

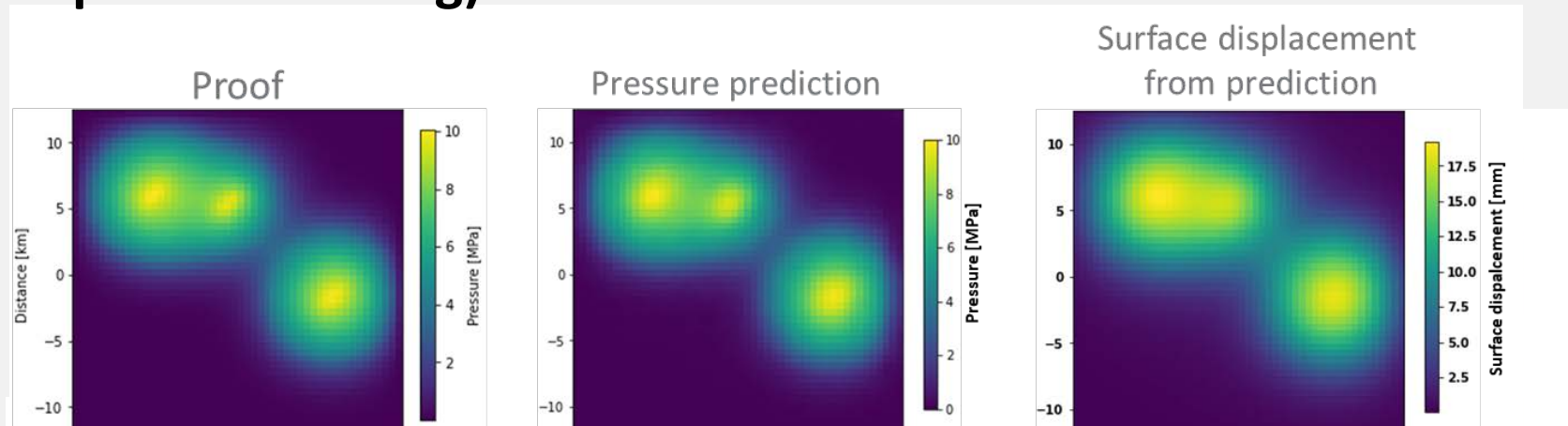

With this framework, we will look into to optimize number of data points or survey layout so that we can minimize the cost, which can be critical for the offshore applications!

# Summary

- **Automatic InSAR data processing:** a routine for automatic change detection-BGS has developed and applies to Hatfield Moors gas storage site → **reduces errors & provides timely and inexpensive access to InSAR.**
- **Fiber optics- monitor static ground movement:** Field experiments performed by RITE in Kyoto, Japan. NGI is doing tests in Oslo, will test later in offshore Germany (September 2021) → **continuous seafloor monitoring.**
- **Fundamental mathematical solution** for calculating ground movement (subsidence or uplift)-considering inhomogeneous, arbitrary number of layers (NGI & Quad Geometrics)
- **Advanced numerical simulation & inversion codes:** for ground deformation (IFPEN, CSIRO, KIGAM, LLNL, UT Austin, IGME, CIUDEN, NGI)

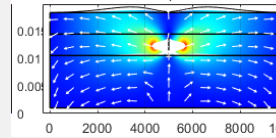
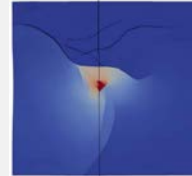
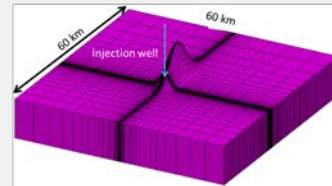
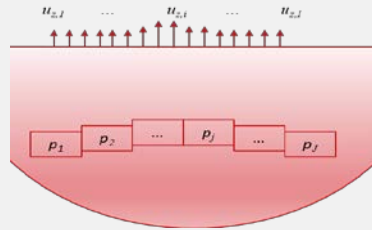
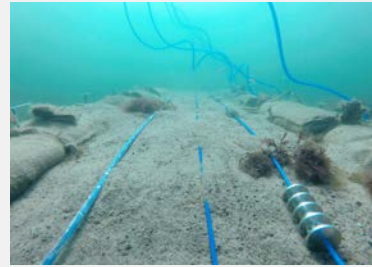
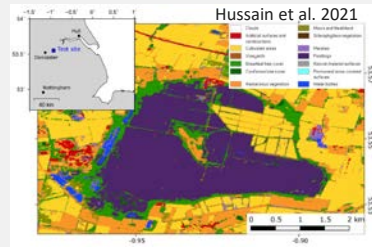



# Summary: ground motion monitoring workflow

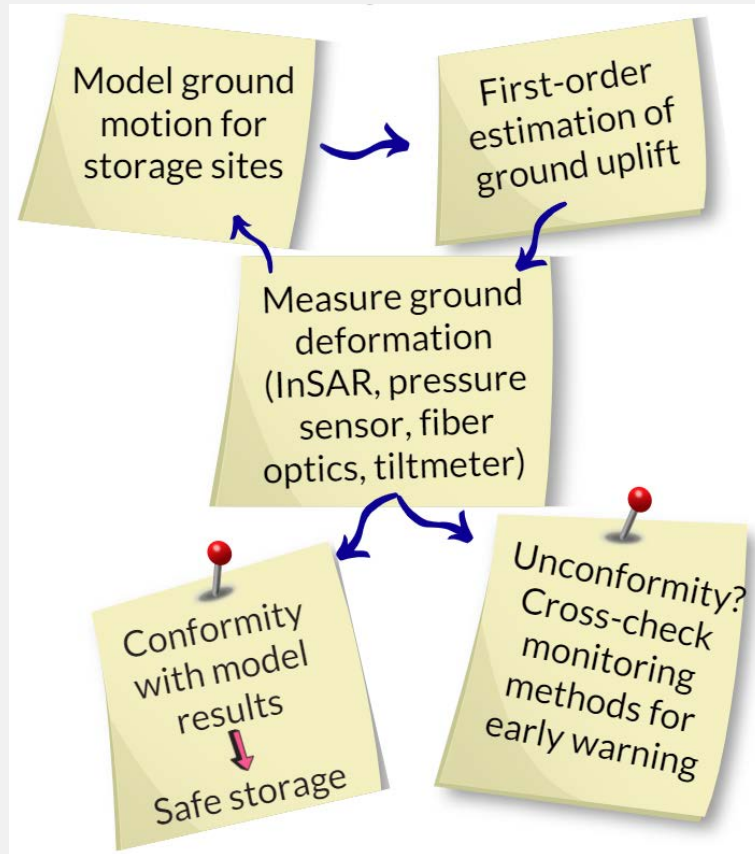

# Monitoring CO<sub>2</sub> Storage Sites

## SENSE Webinar #2 - 25 January 2022

### a) Ground deformation monitoring using fiber optics

By Dr Ziqiu Xue, Chief Researcher, Research Institute of Innovative Technology for the Earth (RITE-Japan); General Manager (Technical Division), Geological Carbon Dioxide Storage Technology Research Association

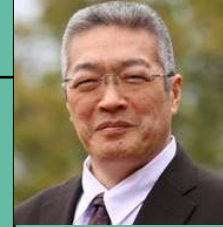

### b) Ground deformation monitoring onshore and offshore

By Mr Per Sparrevik, Technical Expert (Norwegian Geotechnical Institute (NGI- Norway) and Dr Jens Karstens, Postdoc Researcher, GEOMAR (Germany)



#### Event Information:

When: 25 January 2022 at 11:00-12:00 Central European Time (CET)

Where: Online via Teams

Registration via link:

Welcome to join us and hear about the latest advances on CO<sub>2</sub> storage site monitoring & SENSE project <https://sense-act.eu/>



# Acknowledgement



SENSE (Assuring integrity of CO<sub>2</sub> storage sites through ground surface monitoring) project No. 299664, has been subsidized through ACT (EC Project no. 691712) by Gassnova, Norway, United Kingdom Department for Business, Energy and Industrial Strategy, Forschungszentrum Jülich GMBH, Projektträger Jülich, Germany, The French Agency for the Environment and Energy Management, The United States Department of Energy, and State Research Agency, Spain. Additional support from Equinor and Quad Geometrics and permission to use data from the Krechba Field by In Salah Gas JV are appreciated.

